

## Leo 15GT/18GT

### Features

Narrow width of just 780mm, for single doorway access

Patented height and width adjusting track system

Low weight, transportable by trailer and large van or 4x4

Multi-cylinder water cooled KUBOTA diesel engine

230v AC motor for indoor use (110v optional)

Non-marking tracks are standard equipment

### LEO 15GT

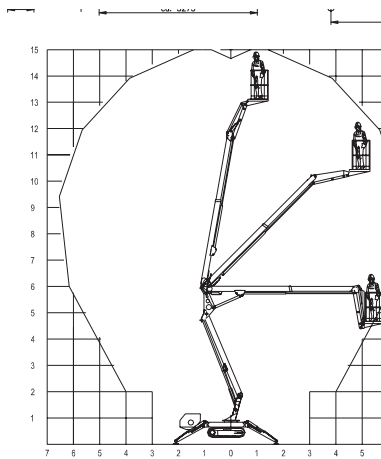

### LEO 18GT

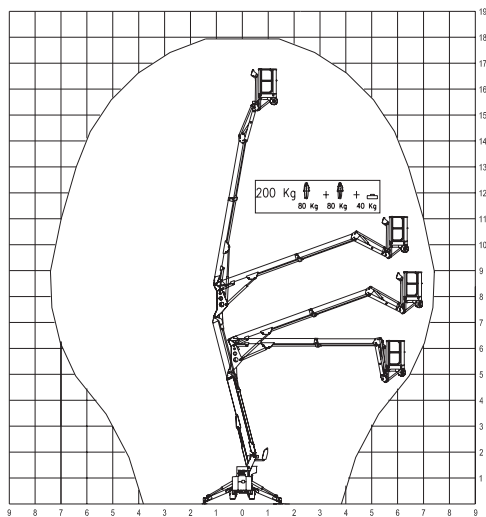

dimensions in metres

### Leo 15/18GT

Flexible 'all rounder' with single doorway access. The quality alternative at the smaller end of the market, these models offer unrivaled performance and flexibility in a very compact package.

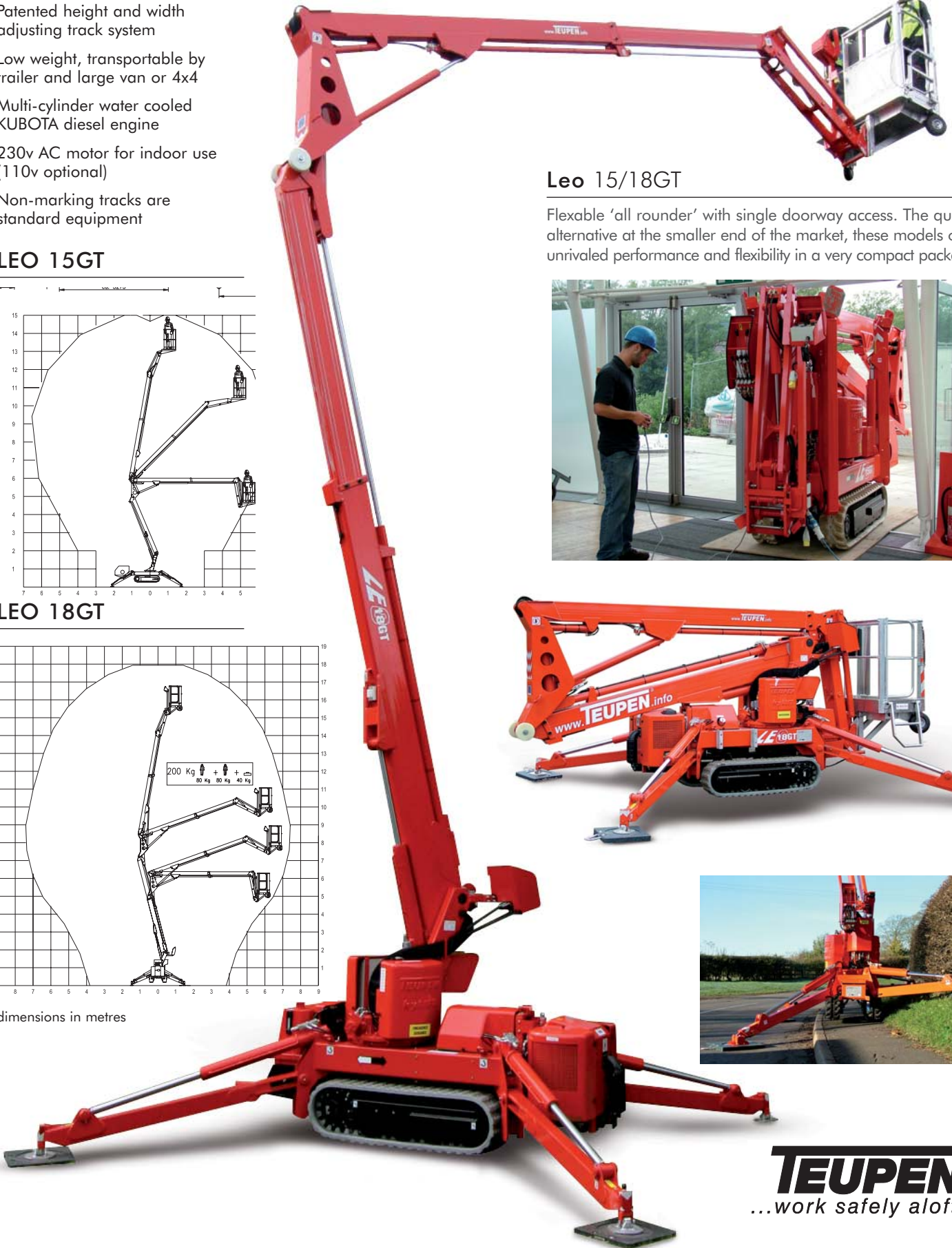

specifications	Leo 15 GT	Leo 18 GT
Working height:	approx. 14.90 m	17.90 m
Platform height:	approx. 12.90 m	15.90 m
Lateral outreach:	approx. 6.40 m	7.60 m
Safe load on cage:	max. 200kg	max. 200kg
Range of rotation:	355°	355°
Size of working cage (LxWxH)	1.2 x 0,7 x 1.1 m	1.2 x 0.7 x 1.1 m
Length in travelling position with the cage:	min. 4710 mm	min. 4710 mm
Length in travelling position without the cage:	min. 3995 mm	min. 3995 mm
Width in travelling position without the cage:	min. 780 mm	min. 780 mm
Height in travelling position:	max. 1995 mm	max. 1995 mm
Total weight:	1920 kg	2330 kg
Loading possibility:	2.65 m x 3.65 m	2.92 m x 3.92 m
Surface load in loading position approx.	approx. 2.16kN/m2	approx. 2.21kN/m2
Ground load (caterpillar-track) in standard work position:	approx. 4.93 N/cm2	approx. 5.52kN/m2
Power line:	inside the profile	inside the profile
Drive:	Honda engine 13	PSHonda engine 13 PS
Adjustable width of caterpillar-track:	780-980 mm	780-980 mm
Creeping angle forward:	-	approx. 36 %
Creeping angle backwards:	-	approx. 28 %
Maximum ground dislevelment:	-	10%
Height-adjustment limit for the rubber track carriage:	-	0.1 m
Crawler belt width:	-	approx. 0.20 m
Travel speed	-	approx. 1.5 km/h
To be jacked up to ground slope: approx.	approx. 14.8 %	-
Climbing ability (in direction of traffic):	approx. 36 %	-
(crosswise to direction of traffic):	approx. 17%	-

options	Leo 15 GT	Leo 18 GT
Ground control with a 3 m long cable	-	Yes
Additional drive: Overweight:: 29kg	230 V AC engine 2.2KW	230 V AC engine 2.2KW
Additional drive: Overweight: 32 kg	Kubota-Diesel Z-482 13.5 PS	Kubota-Diesel Z-482 13.5 PS

Specifications are subject to change without notice.

### LEO 15GT

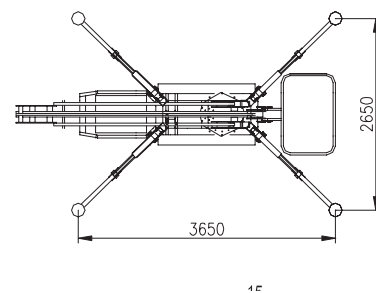
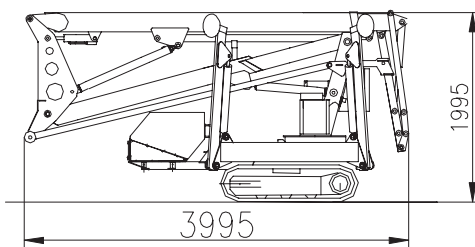
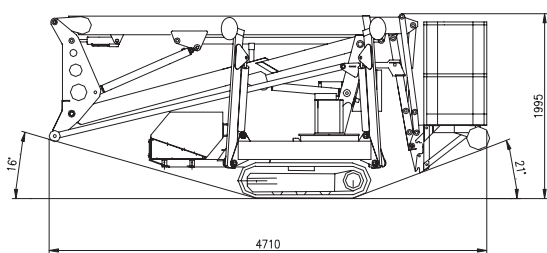

### LEO 18GT

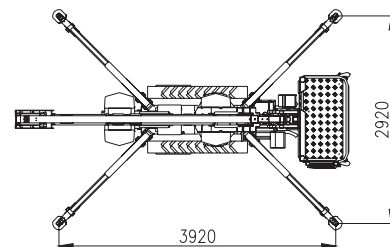
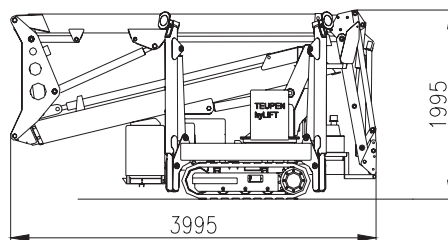
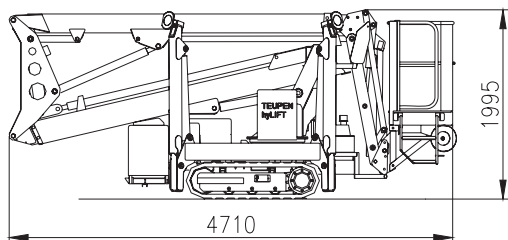

Ranger Equipment Limited.  
 Adelphi Way, Staveley, Chesterfield. S43 3LS.  
 T 0870 225 5554 F 0207 900 2229  
 E info@rangergroup.co.uk  
 www.rangergroup.co.uk